



EVOCAM
Power your productivity

Full-HD (1080p) digital microscope

- Stunning full-HD 1080p/60fps live video image quality
- Effortlessly capture full-HD images direct to USB memory stick (without a PC)
- High quality stand options, built for precision and stability
- Stand-alone, direct to monitor simplicity



FM 584026

Vision Engineering Inc. has been certified for the quality management system ISO 9001:2008.

Unlock the power of full-HD imaging with the EVO Cam high performance digital microscope...

Full-HD live video imaging (1080p/60fps) brings to life a macroscopic world in stunning detail, with magnification options up to 300x and full auto focus to ensure ultra-sharp imaging at all times. Capture full-HD images at the touch of a button (without a PC).



Effortlessly capture full-HD images direct to USB memory stick (without a PC).



Stunning full-HD 1080p/60fps live video image quality.



High quality stand options, built for precision and stability.



EVO Cam is optimized for quality control, testing, inspection and documentation, simplifying precision magnification tasks allowing you to focus on the details.

Highlights

- Live video streaming with exceptional full-HD 1080p/60fps image quality.
- Large 30:1 optical zoom range with wide range of magnification options (up to 300x).
- Simplicity to view whole samples, or the smallest detail at the touch of a button.
- Effortlessly capture full-HD images direct to USB memory stick (without a PC).
- High quality stand options, built for precision and stability. Ideal for industrial and life science applications.
- Stand-alone, direct to monitor simplicity.



Power your productivity

EVOCAM

Exceptional image quality

Leading specification optical performance makes EVO Cam a supremely powerful imaging solution.

- View whole samples, then zoom into the smallest detail with the 30:1 optical zoom.
- Range of wide-field and precision objective lenses providing zoom magnification options up to 300x. Parfocal and parcentric zoom optics means no re-focusing is required when changing magnification.
- Auto (and manual) focus, with auto control of other camera settings (white balance, exposure, brightness) ensures ultra-sharp, high contrast imaging at all times.
- View more detail in shadows and highlights with Wide Dynamic Range (WDR) and Visual Enhancement (VE) modes. Ideal for high contrast subjects, such as reflective metals.

Exceptional simplicity

Simplicity is at the heart of EVO Cam. Intuitive operation minimizes any training requirement, making EVO Cam ideal for multiple users, such as production environments.

- Simplicity of stand-alone operation (without a PC). Capture full-HD images direct to USB memory stick at the touch of a button.
- Know where you are at all times. An 'overview' function allows quick and convenient sample orientation, with on-screen magnification and on/off crosshair display.

Find out more at: www.visioneng.us/evocam »



Illumination

- Integral 8-point LED ringlight ensures optimum shadow-free illumination for all applications. Color temperature 5500K.
- Transmitted substage illumination option permits viewing of a wider range of sample types.

High performance optics

A range of objective lens options ensure stunning results for any application, whether for high magnification, high precision detail work, or for manipulation, re-work and assembly tasks requiring an extra-long working distance.



Precision objective lenses

Ultra-high resolution and contrast, optimized for precision magnification work with definition excellence. Anti-reflective coating and 2" (52mm) filter thread.

Objective lens	0.45x	0.62x	1.0x
Magnification zoom range*	4.0x – 69x (135x)**	5.5x – 93x (184x)**	8.9x – 150x (300x)**
Working distance	6.93" (176mm)	5.04" (128mm)	2.95" (75mm)
Field of view at min. zoom	5.28" x 2.95" (134mm x 75mm)	3.75" x 2.09" (95mm x 53mm)	2.17" x 1.22" (55mm x 31mm)
Field of view at max. zoom	0.32" x 0.18" (8.0mm x 4.5mm) (0.16" x 0.09", 4.0mm x 2.2mm)**	0.22" x 0.13" (5.7mm x 3.2mm) (0.11" x 0.06", 2.8mm x 1.6mm)**	0.13" x 0.08" (3.3mm x 1.9mm) (0.06" x 0.04", 1.6mm x 0.9mm)**

Wide-field objective lenses

Wide field of view, suited for larger subjects. An extra-long working distance provides maximum flexibility and large zoom range for flexible operations. Anti-reflective coating and 2" (52mm) filter thread.

Objective lens	4 diopter	5 diopter
Magnification zoom range*	1.9x – 53x (106x)**	2.4x – 65x (130x)**
Working distance	9.84" (250mm)	7.87" (200mm)
Field of view at min. zoom	11.6" x 6.77" (295mm x 172mm)	9.21" x 5.39" (234mm x 137mm)
Field of view at max. zoom	0.41" x 0.23" (10.3mm x 5.8mm) (0.20" x 0.11", 5.1mm x 2.9mm)**	0.32" x 0.18" (8.2mm x 4.6mm) (0.16" x 0.09", 4.1mm x 2.3mm)**

* with 25" monitor
** with 2x digital zoom

Camera specification

Leading specification optical performance makes EVO Cam a supremely powerful imaging solution.

Camera zoom	30x optical; 2x digital
Camera resolution	Full-HD 1080p, 1920x1080, 1/2.8" CMOS
Frame rate	60fps
Output	HDMI out
Saved file type	.bmp

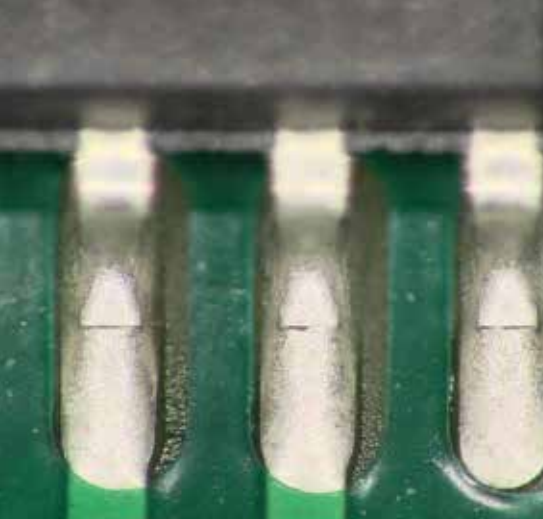

Electronics

An exceptionally large field of view and fatigue-free operation makes EVO Cam ideal for electronics PCB inspection. View the whole PCB, then zoom in to check solder joint quality in stunning detail.



Medical devices

From stents to catheters, hearing aids to surgical implements, medical device components require 100% inspection to the highest possible standards.

View ultra-sharp, high contrast images in microscopic detail, then capture at the touch of a button.

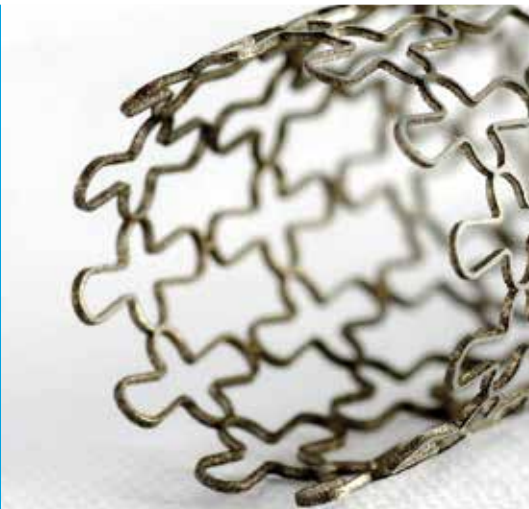

Agriculture

Whether viewing the effects of pesticides on plants, or dissecting and analyzing seeds, the image quality and crisp color rendition of EVO Cam provides a powerful and flexible solution for a wide range of tasks.

Plastics and rubber

A wide range of plastic and rubber components such as seals, caps and closures, or packaging materials are precision manufactured to tight tolerances, making quality inspection essential.

Stunning true color, high contrast imaging makes tasks such as flash removal easy.

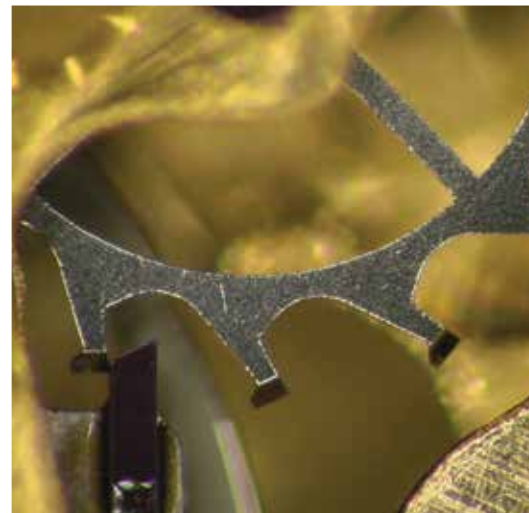

Precision engineering

Precision engineered components cover a very wide range of industries, from aerospace and automotive applications, to watchmaking and general manufacturing.

Stunning live video imaging with amazing simplicity makes EVO Cam an invaluable tool to aid any visual inspection task.



Entomology

Photo-documentation of insects can be challenging with traditional microscope cameras. Exceptional image quality, a wide zoom magnification range and crisp color rendition makes EVO Cam the perfect fit for entomologists.



Remote control console option

In addition to convenient operation of all main functions, the remote control console option provides additional functionality, including:



- Customizable overlay grid and movable cursors for simple on-screen measurement.
- 3x memory settings (illumination, magnification and focus position), allowing optimized settings to be saved/recalled for individual samples.
- Customized camera gain and iris settings, enabling enhanced control of image brightness and depth of focus.

Measurement

EVO Cam includes simple on-screen measurement capability, with customizable overlay grid and cursors. Requires remote control console option.

- Customizable overlay grid allows quick on-screen sizing.
- Cursor mode overlays two movable horizontal and vertical lines, allowing measurement of X,Y values, with results displayed on-screen.

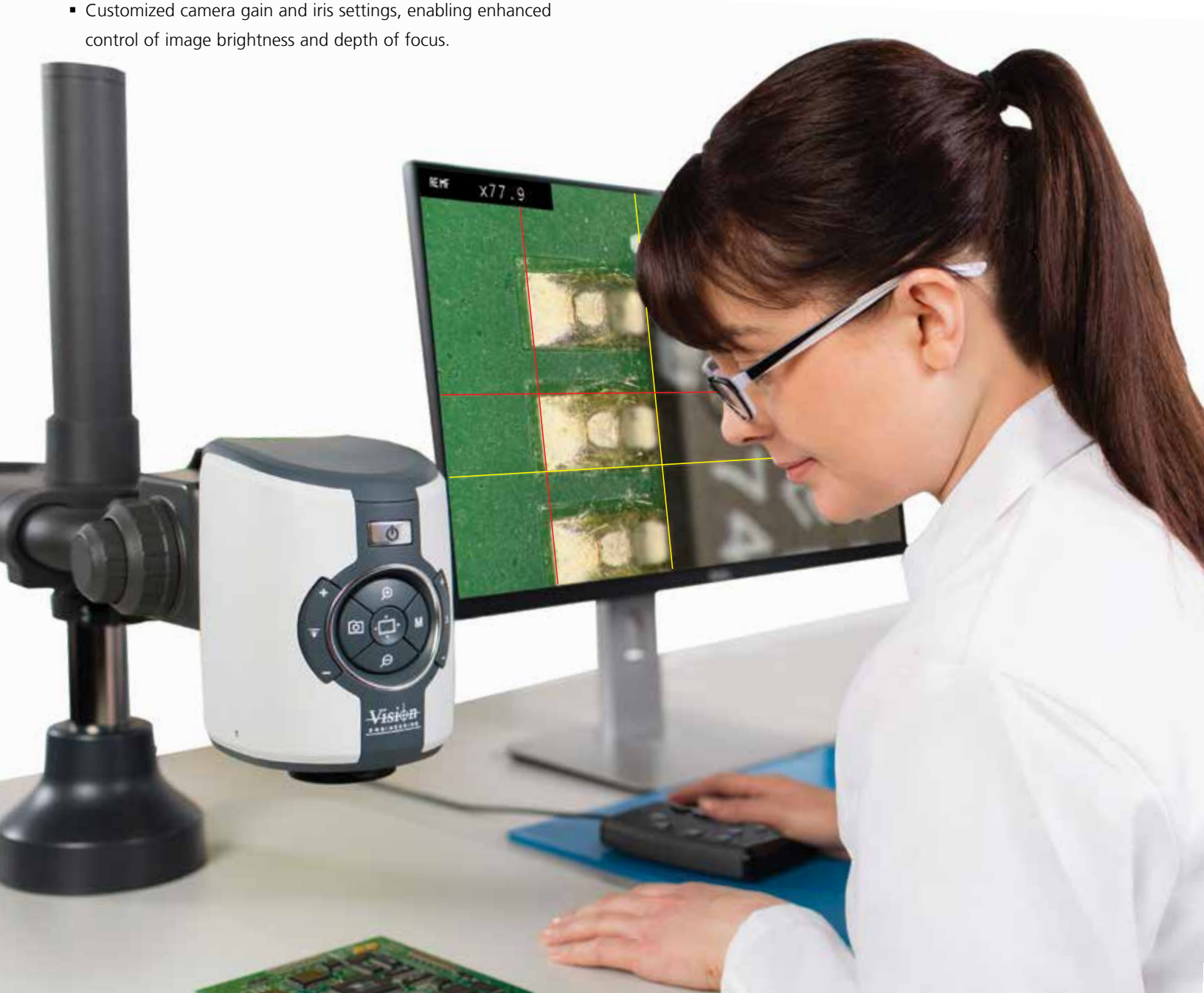

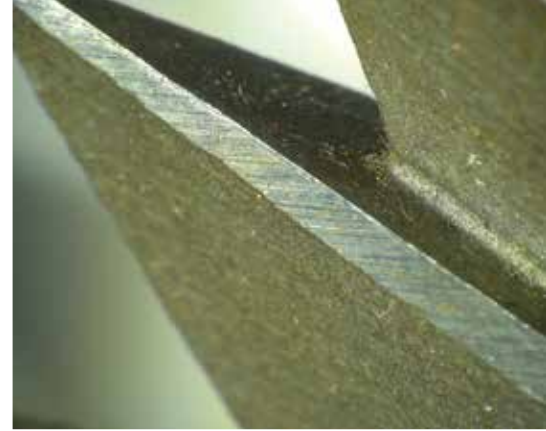
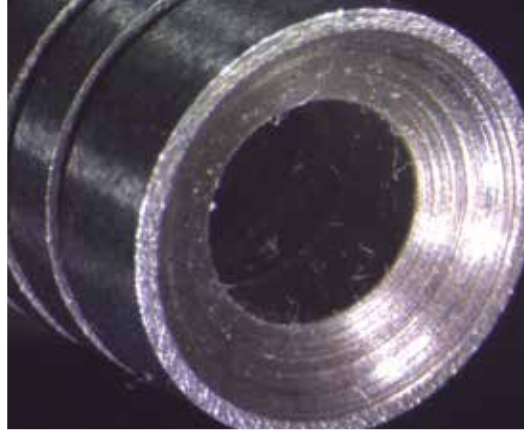
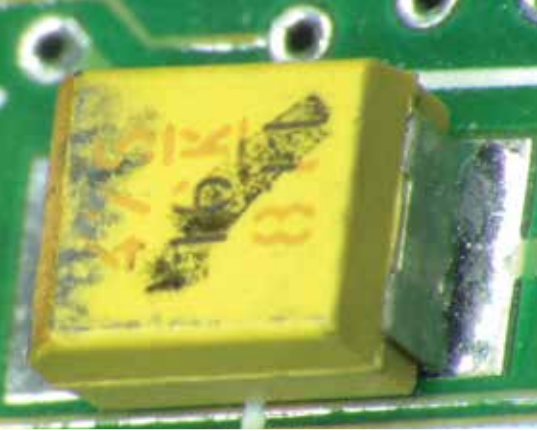

360° rotating viewer

Allows the operator to view a subject from an angle of 34° from vertical, which can be rotated through to 360° enabling a complete all-round view of 3-dimensional subjects.

- The 360° rotation provides enhanced observation for many applications, including electronics, mechanical, medical and plastics components.
- The 34° angle allows details to be seen at the base of any vertical component or feature.
- Simply switch between 360° rotating view and a conventional direct view for ultimate convenience.
- Includes integrated 8-point LED ringlight and objective lens.

360° rotating view					
Zoom ratio	Zoom range	Working distance	Field of view at min. zoom	Field of view at max. zoom	Viewing angle
5.3:1	19x – 105x	35.5mm	25.7mm x 22.1mm	2.6mm x 2.2mm	34° from vertical

Direct view					
Zoom ratio	Zoom range	Working distance	Field of view at min. zoom	Field of view at max. zoom	Viewing angle
5.3:1	28x – 151x	56.5mm	19.7mm x 11.2mm	1.6mm x 0.9mm	-



EVO Cam stand options

Multi-axis stand

- Precise and robust, ideal for industrial applications where maximum work space is desired.
- Integrated gas strut provides counter-balanced adjustability, making operation quick and effortless. Switch between tall components and flat samples with ease.
- Available with platform base, or mounted directly to the work surface.



Ergo stand

- Small footprint providing exceptional stability for high magnification use.
- Transmitted substage illumination option permits viewing of a wider range of sample types.
- Floating stage option provides sensitive control for accurate inspection of samples; ideal for inspecting fragile samples, or for avoiding contamination by handling.



View full details at: www.visioneng.us/evocam »

Technical details

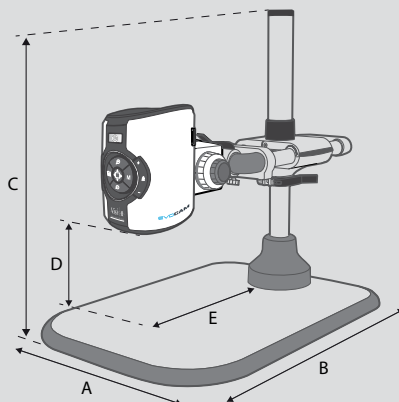

Multi-axis stand dimensions:

- A = 17.9" (455mm), 7.24"*(184mm)*
- B = 26.9" - 32.7" (682mm - 830mm)
- C = 27.2" (691mm) max.
- D = 11.00" (279mm) max.
- E = 17.3" (439mm) max.

* without platform base.

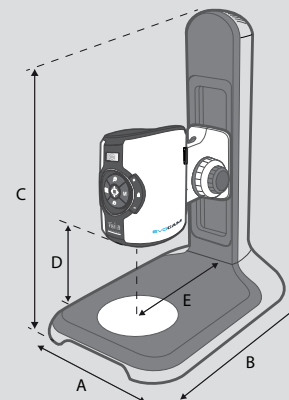

Ergo stand dimensions:

- A = 11.00" (280mm)
- B = 16.5" (420mm)
- C = 20.3" (515mm)
- D = 7.56" (192mm) max.
- E = 7.87" (200mm)



Effortlessly capture full-HD images direct to USB memory stick (without the need for a PC).

Double-arm boom stand

- Designed specifically for applications requiring extended reach, without compromising stability.
- Easy adjustability allows precise positioning and alignment.
- Available with platform base, or with clamp for mounting directly to the work surface.



Articulated arm stand

- Designed for applications requiring extended reach, with ultimate flexibility.
- Multi-point adjustability allows precise positioning and alignment.



Single-arm boom stand

- High stability boom stand, ideal for larger specimens.
- Cost-effective stand option, complete with heavy duty platform base.



Bench stand

- Compact unit with low-profile base and integral transmitted substage illumination.
- Floating stage option provides sensitive control for accurate inspection of samples.



View full details at: www.visioneng.us/evocam »

Floating stage

A floating stage option for the Ergo stand and Bench stand provides smooth and precise control, ideal for checking uniformity of components, or inspecting fragile or sensitive samples.

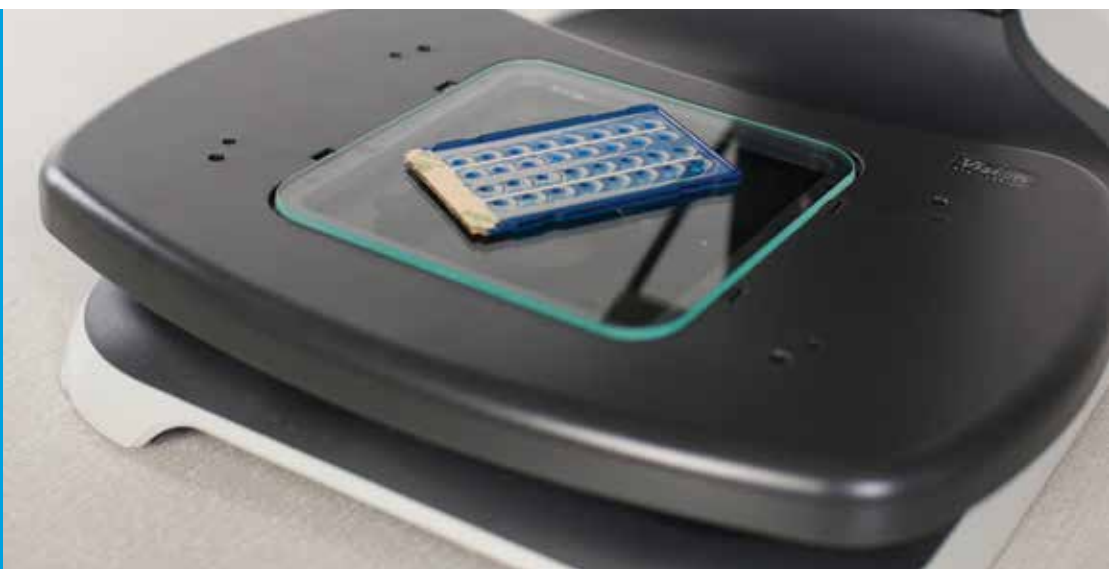

Work in complete comfort...

EVOCAM

The ergonomic advantage

EVO Cam allows operators to work in complete comfort, liberating users from the restrictive working practices of eyepiece microscopes. No eyepieces need adjusting. The monitor image can immediately be viewed by any user, ensuring a comfortable working position is maintained at all times.

Users benefit from dramatically improved comfort and ease of use; businesses benefit from increased productivity and efficiency, driving quality improvements and reduced costs.

Read about our ergonomic advantage:

www.visioneng.us/ergonomics »

“ Good ergonomics is not a ‘nice to have’ feature, but critical to operator performance and productivity ,”

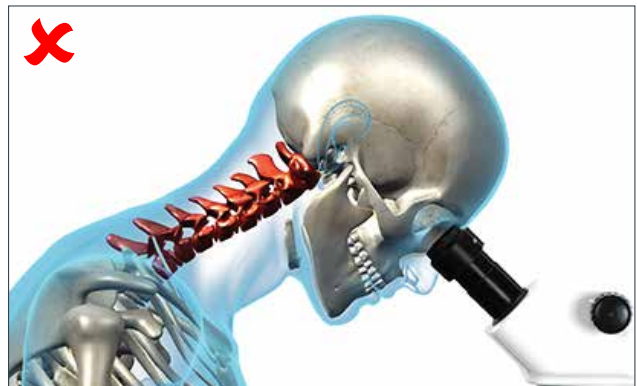

LYNX
EVO

Lynx EVO eyepiece-less stereo microscope

Part of a range of world-leading ergonomic magnification solutions, Lynx EVO is the latest generation of eyepiece-less stereo microscope from Vision Engineering. Lynx EVO liberates users from restrictive working practices, opening up a world of enhanced efficiency through stunning 3D stereo imaging and unrivaled ergonomic performance.

Find out more: www.visioneng.us/lynxevo »

About us

Vision Engineering has been designing and manufacturing ergonomic microscopes for over 50 years. With a philosophy of design innovation, Vision Engineering holds world patents for a number of optical techniques which significantly improve microscope ergonomics. To date, over 300,000 eyepiece-less microscopes have been installed for both industry and life science applications.

ISO 9001:2008

Vision Engineering Ltd is certified for the quality management system ISO 9001:2008.



FM 584026

Contract Manufacturing Services

From product design and design for manufacture, to full production and logistics, Vision Engineering's Manufacturing Services offer comprehensive contract design and manufacturing solutions, giving you access to the latest technology, as well as a highly experienced team of designers and engineers.

www.visioneng.us/manufacturingservices

Stereo microscopes

Vision Engineering's acclaimed eyepiece-less stereo microscopes offer stunning 3D (stereo) imaging combined with unrivalled ergonomics. The patented eyepiece-less designs liberate users from restrictive working practices, opening up a world of enhanced efficiency and productivity.

www.visioneng.us/stereo

Digital inspection

Take advantage of the power of digital imaging with Vision Engineering's range of digital video inspection systems. High resolution images combined with simple operation make digital inspection a powerful alternative for any task requiring precision magnification. The range includes handheld digital solutions for inspection on the move, to full-HD digital imaging with real-time video, for instant results.

www.visioneng.us/digital

Non-contact measurement

Vision Engineering manufacture a full range of non-contact measuring systems, including 'workshop' measuring microscopes, dual optical and video measuring systems, plus the latest ultra-fast 'field of view' measurement systems. Vision Engineering also has a suite of inspection systems and software solutions, designed for simple on-screen dimensioning.

www.visioneng.us/measurement

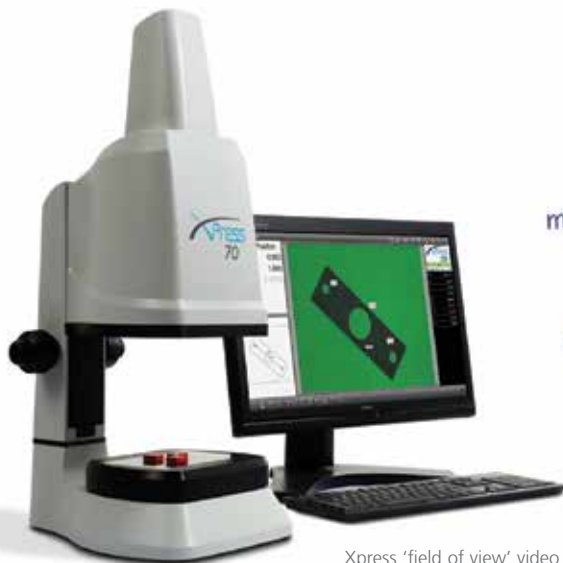

Xpress 'field of view' video measuring machine.



Swift-Duo dual optical and video measuring system.

For more information...

Vision Engineering has a network of offices and technical distributors around the world. For more information, please contact your Vision Engineering branch, local authorized distributor, or visit our website.

Distributor



Disclaimer – Vision Engineering Ltd. has a policy of continuous development and reserves the right to change or update, without notice, the design, materials or specification of any products, the information contained within this brochure/datasheet and to discontinue production or distribution of any of the products described.



Vision Engineering Ltd.
(Manufacturing)
Send Road, Send,
Woking, Surrey, GU23 7ER, England
Tel: +44 (0) 1483 248300
Email: generalinfo@visioneng.com

Vision Engineering Ltd.
(Commercial)
Monument House,
Monument Way West,
Woking, Surrey, GU21 5EN, England
Tel: +44 (0) 1483 248300
Email: generalinfo@visioneng.com

Vision Engineering Inc.
(Manufacturing & Commercial)
570 Danbury Road,
New Milford, CT 06776 USA
Tel: +1 (860) 355 3776
Email: info@visioneng.com

Vision Engineering
(Brasil)
Email: info@visioneng.com.br

Vision Engineering Ltd.
(Central Europe)
Anton-Pendele-Str. 3,
82275 Emmering, Deutschland
Tel: +49 (0) 8141 40167-0
Email: info@visioneng.de

Vision Engineering Ltd.
(France)
ZAC de la Tremblaie,
Av. de la Tremblaie
91220 Le Plessis Paté, France
Tel: +33 (0) 160 76 60 00
Email: info@visioneng.fr

Vision Engineering Ltd.
(Italia)
Via Cesare Cantù, 9
20092 Cinisello Balsamo MI, Italia
Tel: +39 02 6129 3518
Email: info@visioneng.it

Nippon Vision Engineering
(Japan)
272-2 Saedo-cho, Tsuduki-ku,
Yokohama-shi, 224-0054, Japan
Tel: +81 (0) 45 935 1117
Email: info@visioneng.jp

Vision Engineering
(China)
111,
International Ocean Building,
720 Pudong Avenue,
Shanghai,
200120, P.R. China
Tel: +86 (0) 21 5036 7556
Email: info@visioneng.com.cn

Vision Engineering
(South East Asia)
P-03A-20, Impian Meridian,
Jalan Subang 1,
USJ 1, 47600 Subang Jaya,
Selangor Darul Ehsan,
Malaysia
Tel: +604-619 2622
Email: info@visioneng.asia

Vision Engineering
(India)
Email: info@visioneng.co.in

Visit our multi-lingual website:

www.visioneng.us